

# CONTINUOUS TREATER KB 50

## GENERAL

Brand	Cimbria
Designation	Continuous treater
Model	KB 50
Use	Industry



## Application

The continuous treater is built for continuous treating of seeds. For this purpose a treating liquid or slurry is applied to the seed.

The machine has been designed in self-supporting all-steel construction. All metal parts in direct contact with the treating agents are made of stainless steel.

## Process flow

- 1. Intake hopper with feeder**  
 The grain passes the rotary feeder which is equipped with an air classifier. The intake capacity can be adjusted by changing the speed of the rotary feeder.
- 2. Spray chamber (primary treatment)**  
 The product is distributed via a dispersal cone. The treating liquid passes through a hose pump into the spray chamber and is spread over the spinning disc on the product. The volume of the treating liquid can be adjusted by the rotation speed of the hose pump. The spinning disc is driven by a belt drive.
- 3. Mixing chamber (secondary treatment)**  
 The paddle screw mixing the product and carries to the outlet.
- 4. Control unit**  
 The control of the system could be done either by PLC or by relay control

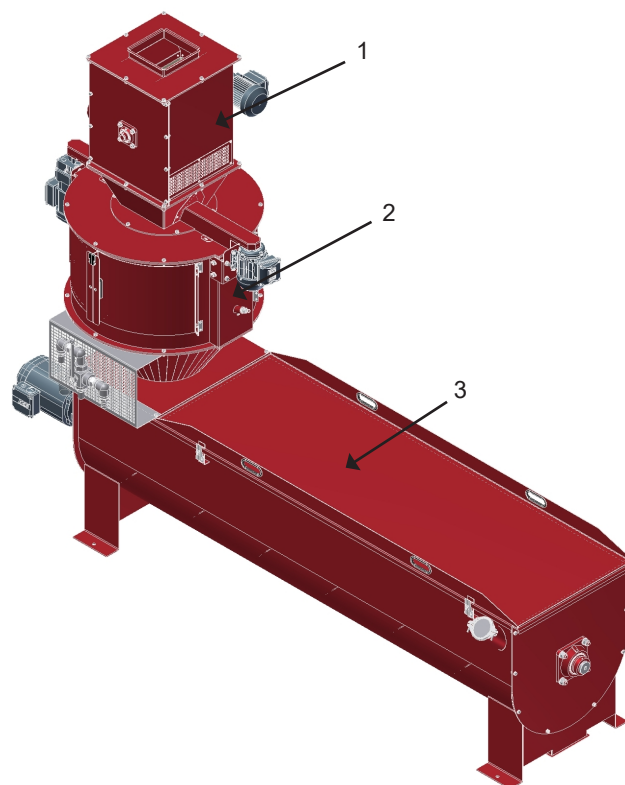

Technical data	
Capacity	
Wheat	35.0–50.0 t/h
Total power requirement (with one liquid dosing pump)	4.42 kW
Power supply	3/N/PE 400 V, 50 Hz
Aspiration	810 m <sup>3</sup> /h
Dimensions	
Length	3 175 mm
Width	935 mm
Height	2 345 mm
Total weight of treater	
Net	590 kg

Technical data can vary for certain of the above due to continued development or a different machine composition.